

Edited by Foxit PDF Editor
Copyright (c) by Foxit Software Company, 2004 - 2007
For Evaluation Only.

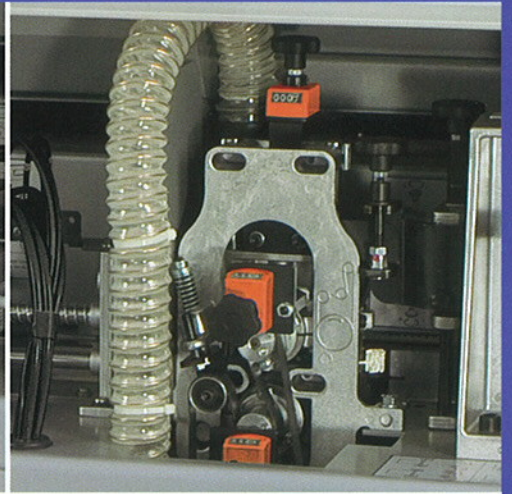

B | S E R I E S

BEE

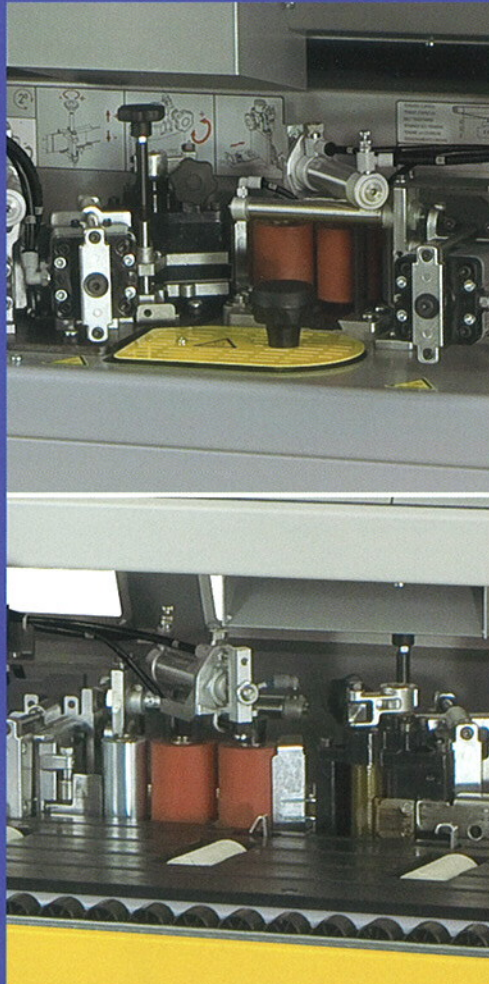

Freival

Bordatrice
Edge Bander



Vantaggi

- ✓ Vasca colla con Teflon®
Glue pot with Teflon®
- ✓ Taglio del bordo in rotolo PVC 2÷3 mm
Guillotine for PVC 2÷3 mm
- ✓ Rullo motorizzato
Pressure roller driven
- ✓ Refilatore con indicatore di posizione
Heavy duty bevel trim unit with a single digital reader
- ✓ Raschiacolla
Scraping Glue

Advantage



CARBE
www.carbe.cz

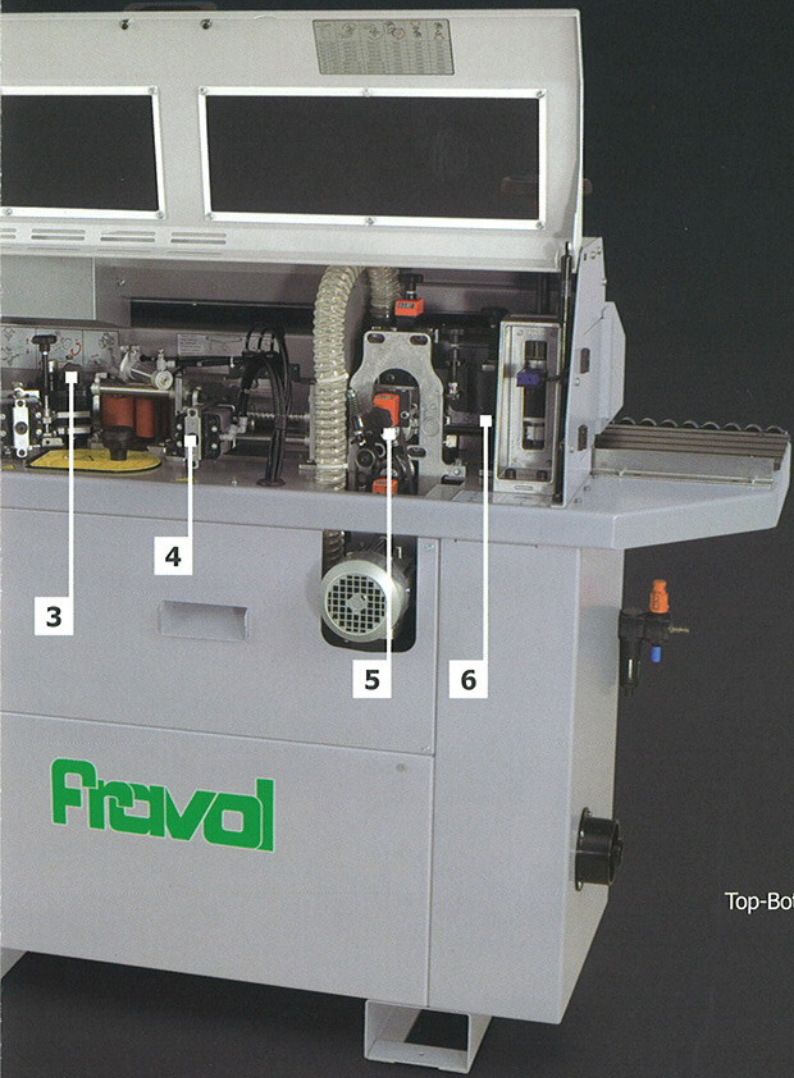

Indicatore di posizione I
 Position indicator GB
 Indicateurs de position F
 Positionsanzeige D
 Indicadores de posición E

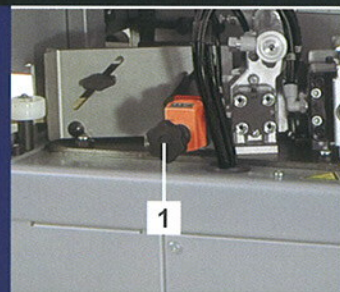

Caricatore automatico bordi I
 Edge-Feeding GB
 Charger le chant F
 Kante zuführen D
 Alimentación del canto E

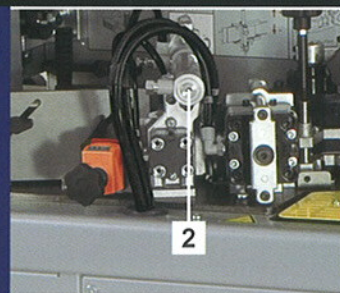

Incollaggio I
 Pressure Zone GB
 Encollage F
 Anleimen D
 Encolado E

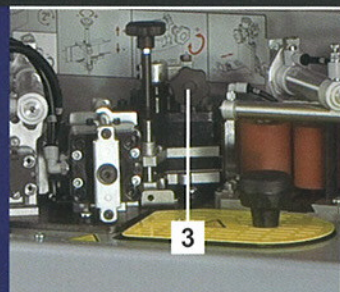
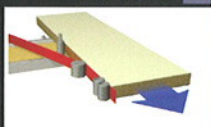

Intestatore I
 End-Trimming GB
 Abouters F
 Kappen D
 Retestador E

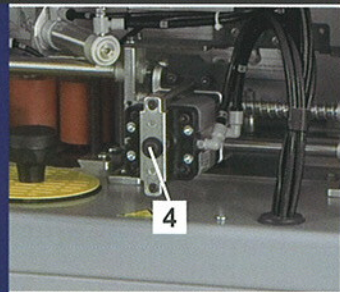
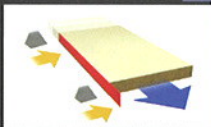

Rifilatore sovrapposto I
 Top-Bottom Roughing Unit (Flush) GB
 Dégrossés F
 Vorfräsen (Planfräsen) D
 Desbastador E

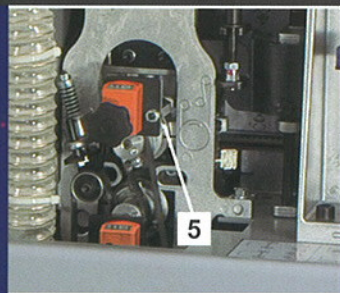
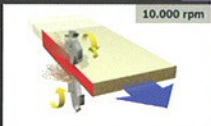

Raschia colla I
 Scraping Glue GB
 Racleur Colle F
 Nachputzen Lime D
 Rascador de Cola E

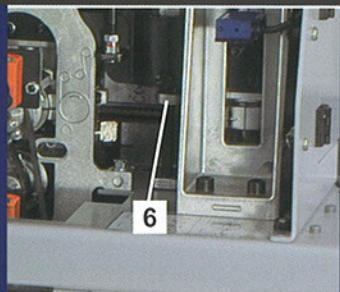
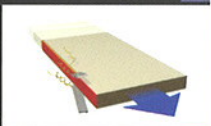

UM	A	B	C
BEE mm	1830	730	1480

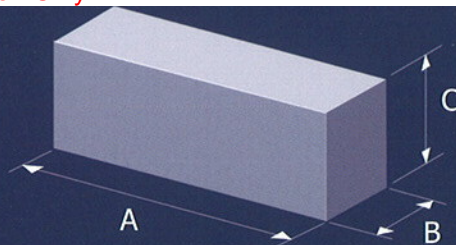

Dati tecnici - Specifications

Modello
 Model
 Modèle
 Modell
 Modelo



Spessore pannello Panel thickness Espaisseur panneau Werkstückdicke Espesor panel	13 ÷ 45 mm
Larghezza pannello Panel width Largeur Panneau Werkstücklänge Ancho panel	min. 65 mm
Altezza bordo Edge width Largeur chant Kantenbreite Anchura canto	16 ÷ 48 mm
Spessore bordo Edge thickness Espaisseur chant Kantendicke Espesor canto	0.4 ÷ 3 mm
Avanzamento Feed Avancement Vorschub Avance	5 m/min
Voltaggio Voltage Voltage Spannung Voltaje	220/380 V 50/60 Hz - 3 Ph
Lunghezza pannello Panel length Longeur panel Werkstücklänge Largo panel	min. 140 mm
Potenza installata Installed power Puissance installée Leistung installierte Potencia installada	1.94 Kw
Potenza pneumatico Pneumatic power Puissance pneumatique Leistung pneumatik Potencia neumático	6 bar
Peso Kg. Weight Kgs. Poids Kgs. Gewicht Kgs. Peso Kgs.	260

Dimensioni - Dimensions - Dimensions Abmessungen - Medidas

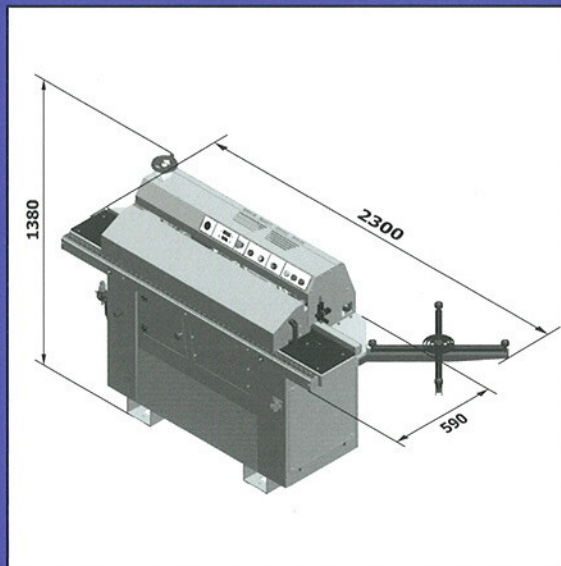

La Ditta si riserva di apportare qualsiasi modifica senza preavviso. - The Company reserves the right to alter any detail with no forewarning. - La maison réserve le droit d'apporter les modifications jugées utiles sans préavis. - Die Firma behält sich das Recht für Änderungen ohne Voranzeige vor. - La empresa se reserva cualquier modificación sin preavisar a los clientes.

Fravol

MACCHINE PER LA LAVORAZIONE DEL LEGNO
 MANUFACTURE OF WOODWORKING MACHINES

Uff. e Dep.: Via A. Niedda, 6 - 35010 PERAGA di Vigonza - (PD) - Italy
 Tel. +39 - 049 725085 - 725888 - Fax +39 - 049 8931635
 www.fravol.it - e-mail: fravol@fravol.it

DEALER

CARBE

www.carbe.cz